

# TRP-C08H

**USB To 2\* RS232 and 2\*RS422/485 Isolated Converter**



## User's Manual

Printed Jun. 2008 Rev 1.5

Trycom Technology Co., Ltd 1F, No.2-11, Sihu street, Yingge Township, Taipei, Taiwan ROC Tel: 886-2-86781191,  
Fax: 886-2-86781172 Web: [www.trycom.com.tw](http://www.trycom.com.tw)

### Copyright

Copyright Notice: The information in this manual is subject to change without prior notice in order to improve reliability, design and function and does not represent a commitment on the part of the manufacturer. No part of this manual may be reproduced, copied, or transmitted in any form without the prior written permission of manufacturer. Acknowledgment Products mentioned in this manual are mentioned for identification purpose only. Products names appearing in this manual may or may not be registered trademarks or copyright of their respective companies.

## 1. Introduction

The TRP-C08H allows you to connect 4 serial devices simultaneously by using a USB interface. With auto configuration in data format, baud rate and RS485 data flow direction control TRP-C08H is able to automatically configure RS-232, RS-422 and RS-485 signals, data format and baud rate without outer switch setting. TRP-C08H is equipped with 3000V DC of isolation and internal surge protection on each data line to protect the computer and converter against high voltage spikes, as well as ground potential differences. TRP-C08H also features a high-speed 256 Kbps transmission rate and supports various O.S. The industry DIN rail and panel mounting design enable user a fast and professional installation.

### 1-1. Features

- USB-2.0 Device Controller.
- On-Chip 512-Byte FIFO for upstream and downstream data transfers for serial Port.
- System gets four serial port when the converter plug in.
- Auto switching RS422/485 detecting.
- Auto direction flow control on RS485.
- Auto baud rate switching from 300bps to 256 Kbps.
- Direct power from USB port , no need external power supply.
- 3000 VDC isolation protection on RS422/485.
- Surge protection on RS422/485 data line.
- Power and TXA/RXA/TXB/RXB communication LED indicator
- Din-Rail (option)or panel mount Driver support:
- Vista64/32,Windows 98/ME/2000/XP/CE3.0, and Linux, and Mac OS

### 1-2. Specification.

- Input: USB 2.0 protocol.
- RS232 output: Standard 9 pin DTE full-duplex.
- RS422 output: Differential 4 full-duplex wires (TX+, RX+, TX-, RX-)
- RS485 output: Differential 2 half-duplex wires (D+, D-).
- Data Format: Asynchronous data with all common combination of bits, parity, stop
  - Parity type: None, odd, even mark, space.
  - Data bit: 5, 6, 7, 8
  - Stop bits: 1, 1.5, 2.
- Cable: USB 2.0 type A to type B cable.
- Communication speed: form 300bps to 256Kbps.
- RS-422/485 line protection: Against surge, short circuit,+/- 15KV ESD and voltage peak.
- RS-232 line protection: +/- 15KV ESD.
- Distance: RS-422/485 Up to 4000ft (1250M).
- Connection type: Screw terminal for maximum AWG #12~30 wire.
- DIN rail and panel mount support.
- Power consumption: 260mA by USB power.
- RS422/485 Optical Isolation: 3000V DC.
- Operating environment: 0 to 65 °C
- Storage temperature: -20 to 65 °C
- Dimension: 151mm X 75mm X 26mm.
- Weight: 395g.
- Humidity: 10-90% non-condensing.

## 2. Hardware Description

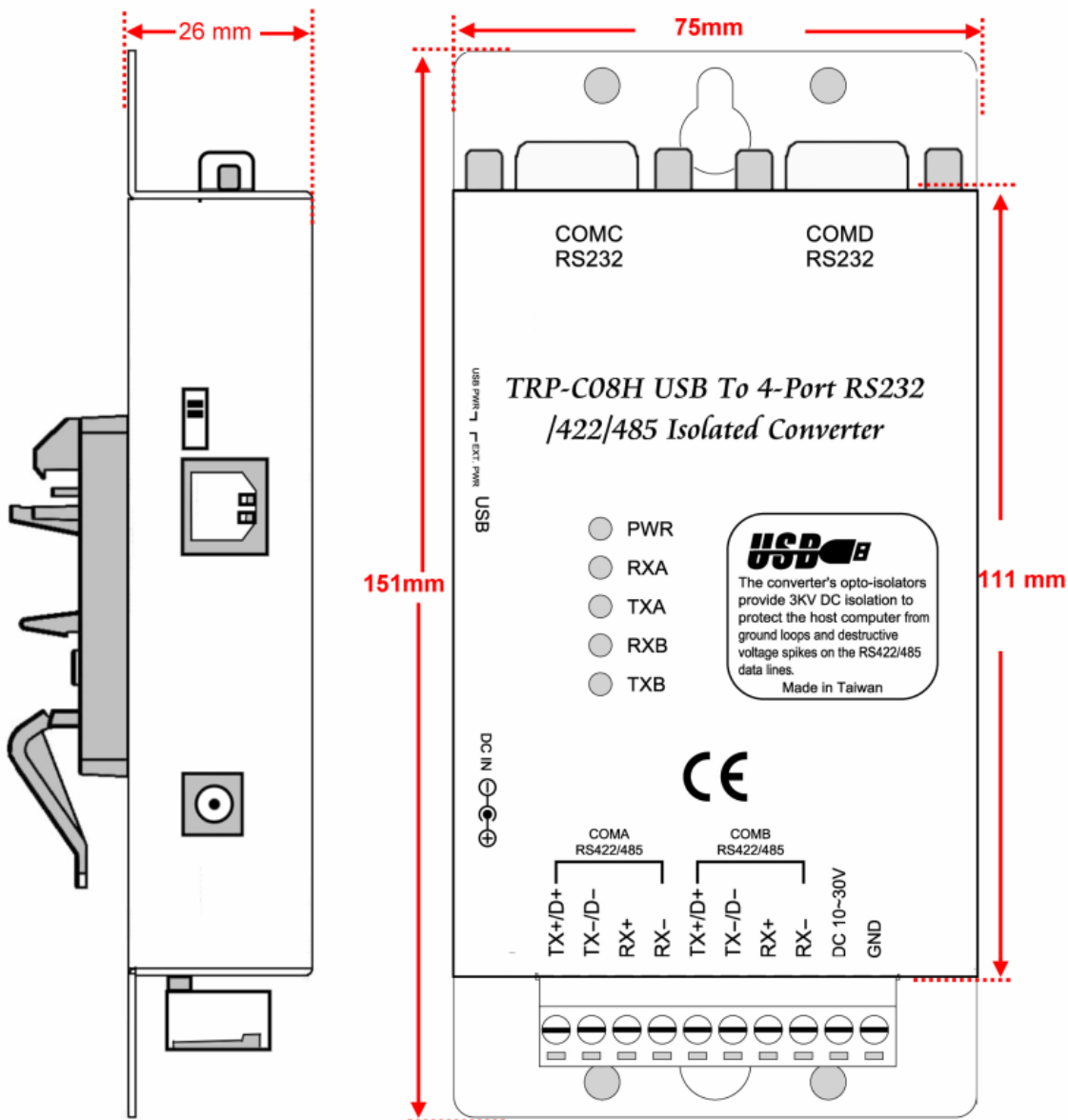

### 2-1. Panel layout

### 2-2. LED Indicator

**PWR LED:** System is ready.

**RXA LED:** COMA-RS422/485 Receiving.

**TXA LED:** COMA-RS422/485 Transmitting.

**RXB LED:** COMB-RS232 Receiving.

**TXB LED:** COMB-RS232 Transmitting.

### 2-3. Serial Connection

The TRP-C08H has two DB-9 male connector and dual 4-PIN RS422/485 connector. The serial port is configured as a DTE (data terminal equipment) device. All PC COM ports are DTE ports. A null modem cable is required to make a connection between the PC COM port and the TRP-C08H serial port.

### 2-4. Power Connection

A power selection dip switch allows the TRP-C08H USB power source enable or disable. User may select the power source by power select switch. The method is as below.

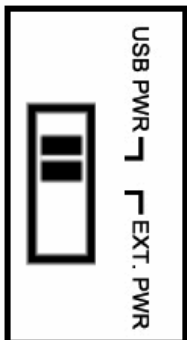

1. Find the power select switch which is located at the right side of USB port.
2. Move the switch to “USB PWR” position to enable USB power input, and disable screw terminal and external DC adapter. User may input power from USB port by USB A/B cable.
3. Move the switch to “EXT PWR” position to disable USB power input, and enable screw terminal and external DC adapter, user may input power from either screw terminal block or DC adapter.

### 2-5. USB Connection

The TRP-C08H has a USB B-Type connector which is fully compliant with USB 2.0, the full rate speed up to 256Kbps.

**\*Please using the USB 2.0 cable ensures the TRP-C08H working ok!**

### 2-6. RS485 Wiring

The RS-485 mode supports the Transmit and Receive channels using 2-wire half-duplex operation.

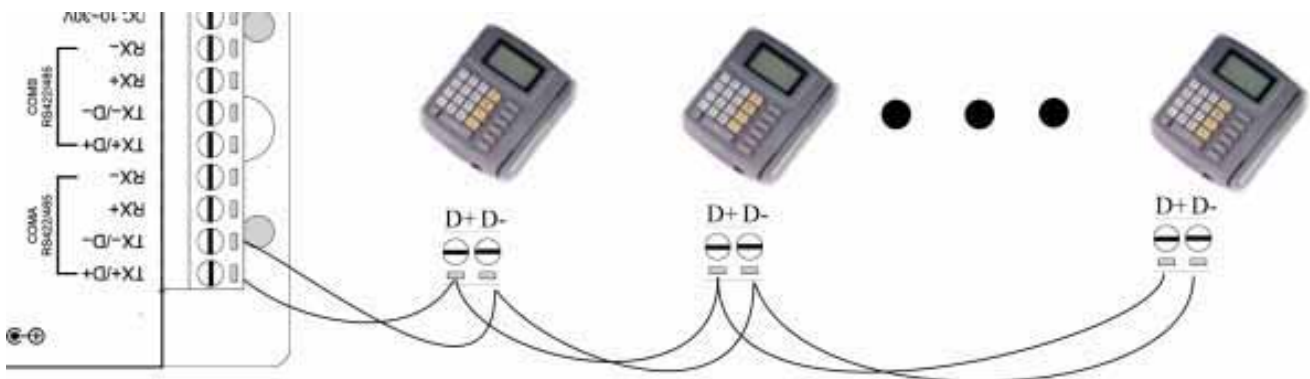

## 2-7. RS422 Wiring

The RS-422 mode supports 4 channels with full duplex operation for Receive, Transmit, the data lines are in differential pairs.

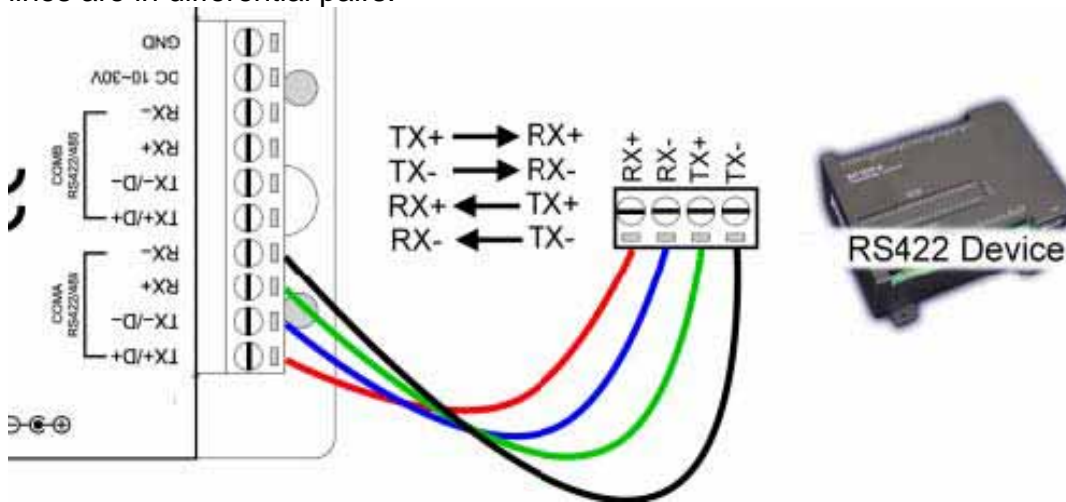

## 2-8. RS232 Wiring

The RS-232 supports 8 channels plus Signal Ground and is configured as DTE like a computer. Signals are single ended and referenced to Ground. To use handshaking, Flow Control must be set to RTS/CTS during configuration. Refer to the Pin out table for connections.

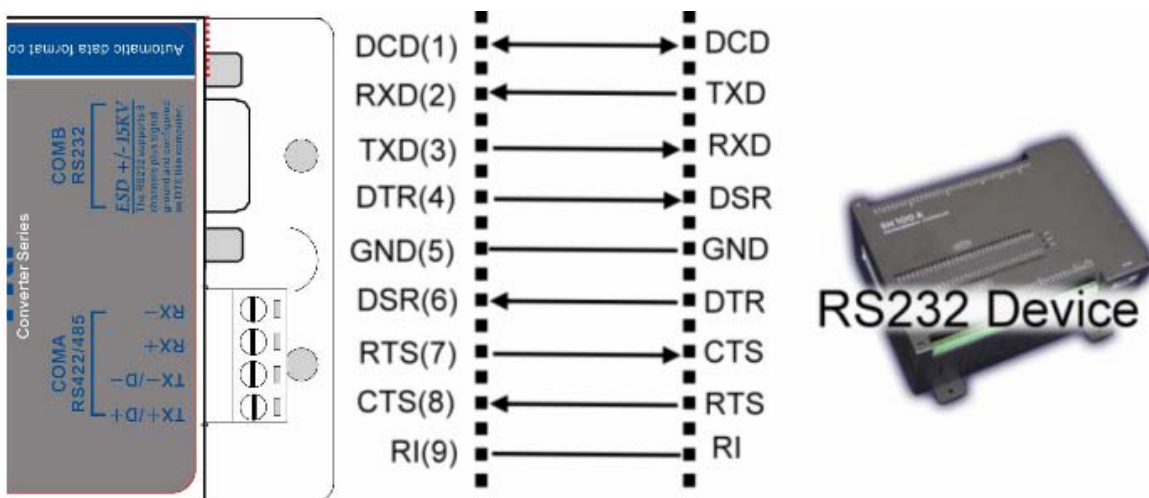

## 2-9. USB Cable Wiring

TRP-C08H is true USB 2.0 specification; it also supports USB V1.0, V1.1 standard. It is strongly to recommend user use the standard A to B type USB 2.0 cable if USB1.0 cable can not work properly.

## 3. TRP-C08H Software Installation.

1. Power on your computer and boot to Windows.
2. Put the driver CD in the CD-ROM then select the driver of O.S you want (See figure1)

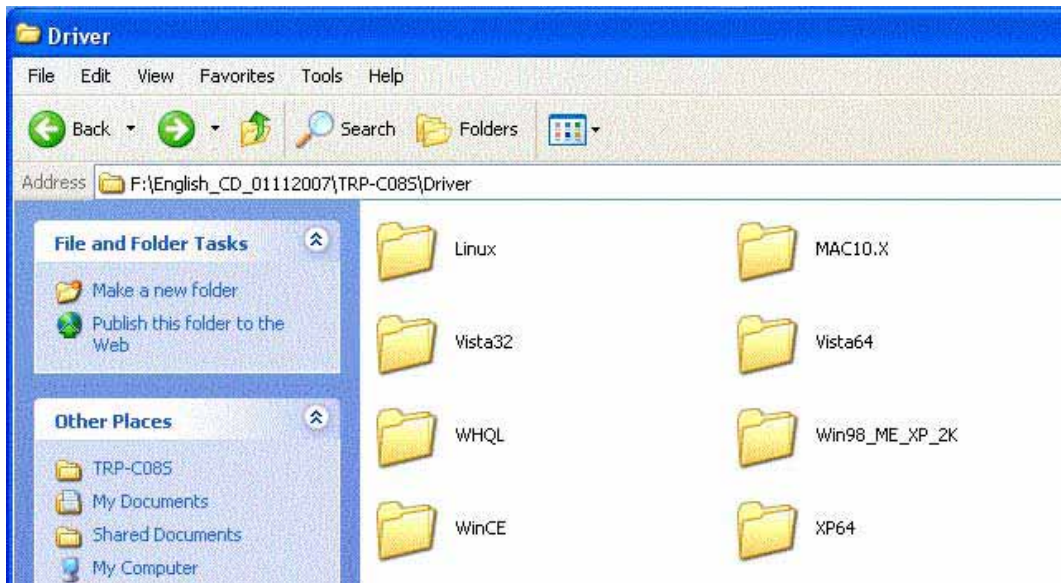

Fig.1

### 3-1 .Install Vista32/64 driver

Find “MSSetup.exe” utility which in the Vista64 folder. Double click on MSSetup.exe to start the installation process. Make sure that the User installing the driver must be a member of the Administrator group on the system

You will get a “User Account Control” window saying “*An unidentified program wants access to your computer*”. Click on *Allow* to continue installing the Driver.

You will get an installation window as below, press “Install” button to install the drivers for High-Speed USB Multi Serial Device.



During the installation process, a “Windows Security” warning message pops up informing that “*Windows cannot verify the publisher of this driver software*”. Ignore the warning message by clicking on the option “*install this driver software anyway*”.





You will get the above message two times and you have to select “*install this driver software anyway*”. The utility displays a message stating “Installation completed”. Use “Exit” button to complete the driver installation.



### 3-1-1. TRP-C08H Device Installation & Detection:

Connect TRP-C08H to the USB Host controller of the PC using a USB cable. The first time you plug-in the cable into the USB port, Windows will start installing the device driver software. You can see the installation status at the pop-up message of system tray. After installation, the pop-up message says “*Your devices are ready to use*”, *Device driver software installed successfully*.

TRP-C08H device detection can be confirmed by checking at the Device manager. Check for “*High-Speed USB MultiSerial Compound Device*” under *Universal Serial Bus controllers* and you will find “*High-Speed USB Serial Port (ComX)*” under the category *Ports (COM & LPT)*. Here ‘X’ in ‘ComX’ represents the serial port number. You can see the same in the figure below.

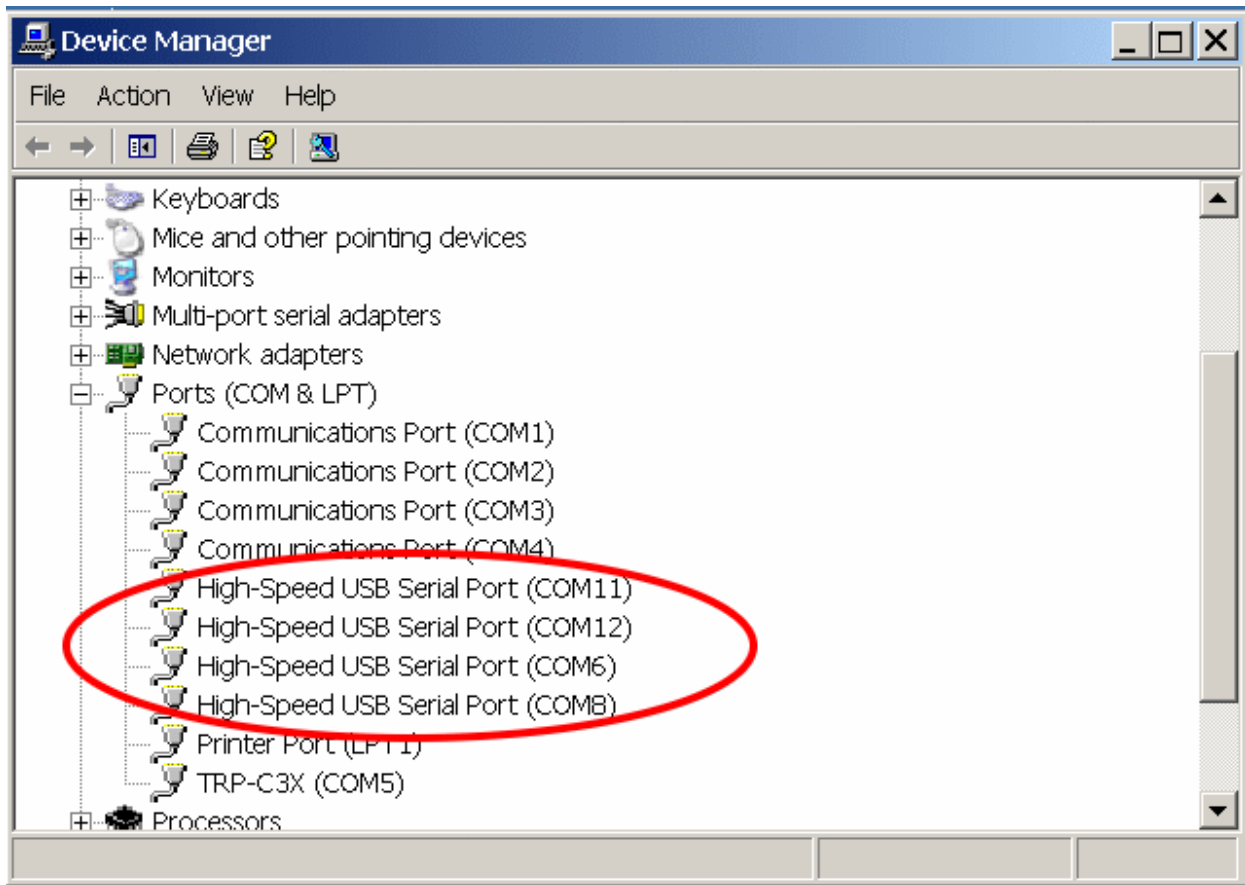

### 3-2 .Install XP driver

Find MSSetup.exe and MSUninst.exe which in the folders for Win XP/2K and Win98/ME operation system.

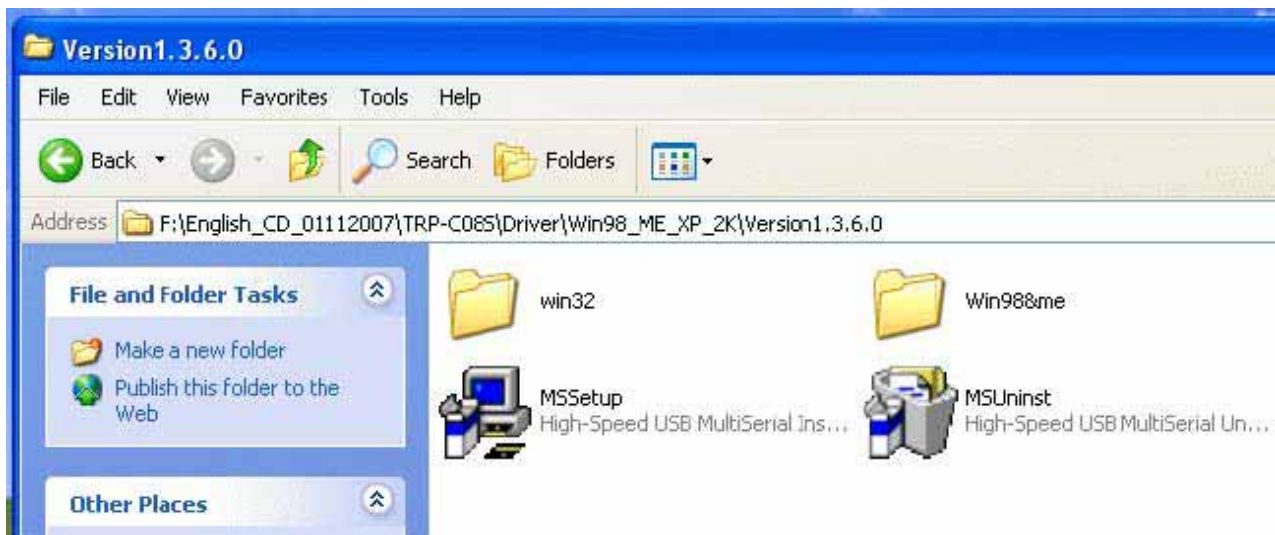

Use “MSSetup.exe” utility to install the driver. Double click on the utility to start the installation process. Press “Install” button to install the drivers for High-Speed USB Multi serial Device.





During the installation process, a warning message will popup informing the user that the software being used has not passed the Windows Logo testing. You can ignore the warning message by clicking on the option “**Continue Anyway**”.



The utility will display a message stating “Installation completed”. Use “**Exit**” button to complete the driver installation.



Connect TRP-C08H to the USB Host controller of the PC by using a USB cable. The first time you plug the adapter into the USB port, Windows will bring up the "**Found New Hardware Wizard**" window to guide you through the initial configuration process. Select the option "**No, not this time**" and click on "**Next**" button to continue.

The following wizard helps you install the software for "High-Speed USB Multi Serial Compound device". Select the option "**Install the software automatically**" and click on "**Next**" to proceed further.



As specified in earlier section, a warning message will popup informing the user that the software being used has not passed the Windows Logo testing. You can ignore the warning message by

clicking on the option “Continue Anyway”.

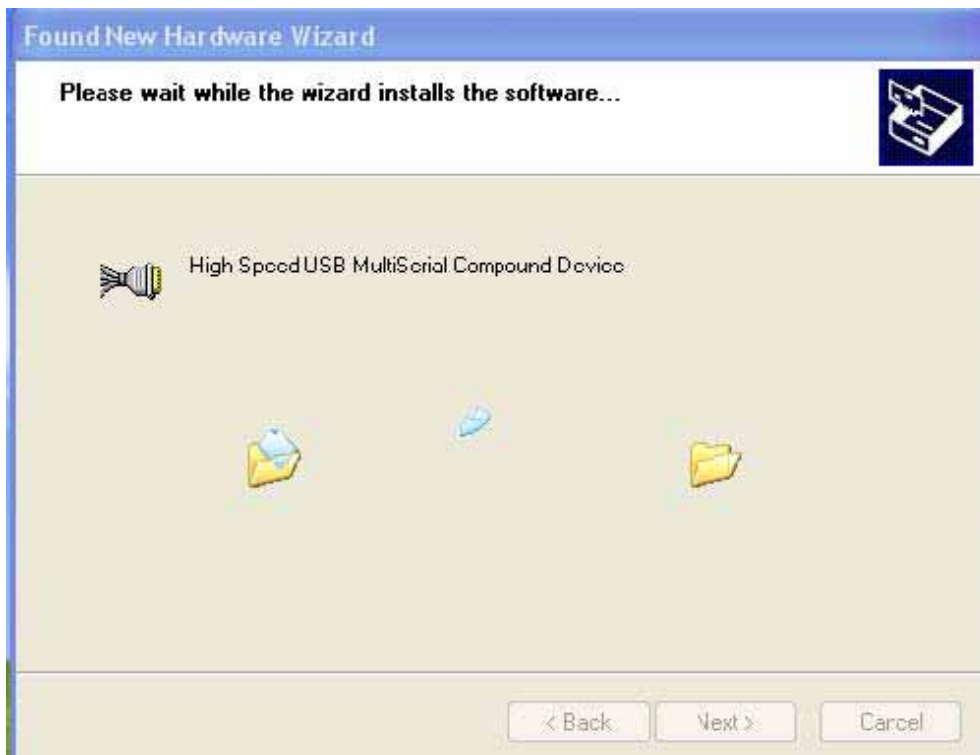

The following window conveys that the OS had finished the software installation for “High-Speed USB Multi Serial Compound Device”. Click on “Finish” to complete found new hardware wizard.



Follow the same steps as explained for “High-Speed USB Multi Serial Compound Device” for the second port installation . Select the option “**Install the software automatically**” .....



“Continue Anyway”... ..



The following wizard indicates that the OS has completed installing the software for the first serial port. Continue the same process for installing the rest of the serial ports.



TRP-C08H device detection can be confirmed by checking the Device manager. Check for “High-Speed USB Multi Serial Compound Device” under Universal Serial Bus Controllers and “High-Speed USB Serial Port (Com X)” under the category Ports (COM & LPT)

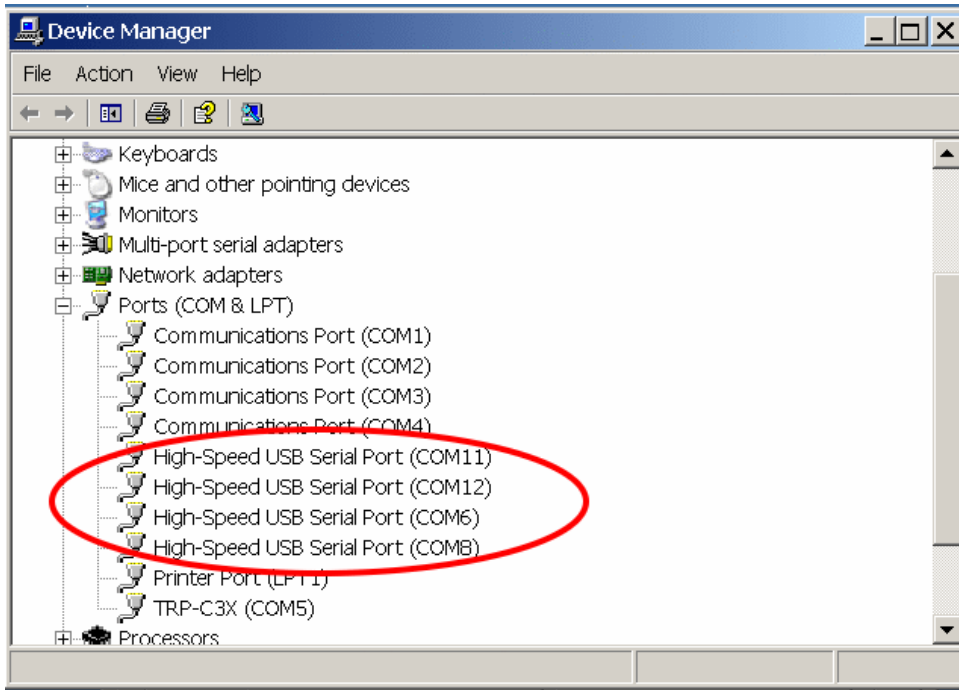

**Now the TRP-C08H Device is ready to use.**

**3-3 .Uninstall XP driver** Use “MSUninst.exe” to uninstall the TRP-C08H device driver from your PC. Double click on the utility to run the Uninstaller. Click on **OK** to proceed further.



Use the “**Exit**” button to complete the Uninstaller utility. No need to restart the PC, unless prompted by the OS. The driver can also be uninstalled from **Control panel – Add / Remove Programs**. Select the “High-Speed Multi Serial Compound Device” from the Add / Remove panel and click on “**Remove**” option. This will remove the MCSTRP-C08H device driver from the PC.



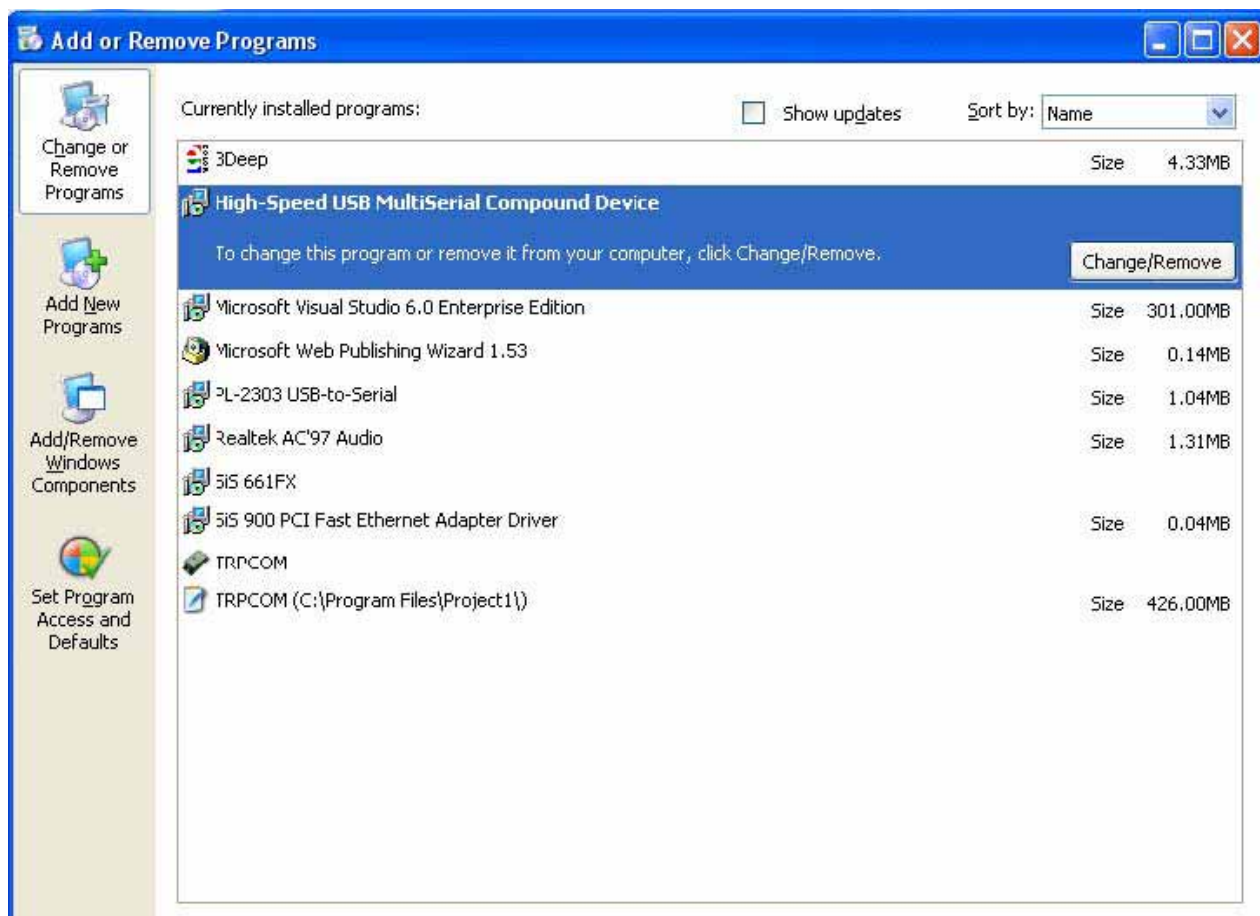

The TRP-C08H device driver can be un-loaded through “**Device Manager**” as well. Go to Device Manager, Select High-Speed USB Multi Serial Compound Device from the Universal serial Bus controllers, Right Click on it, Select “**Uninstall**” as shown below.

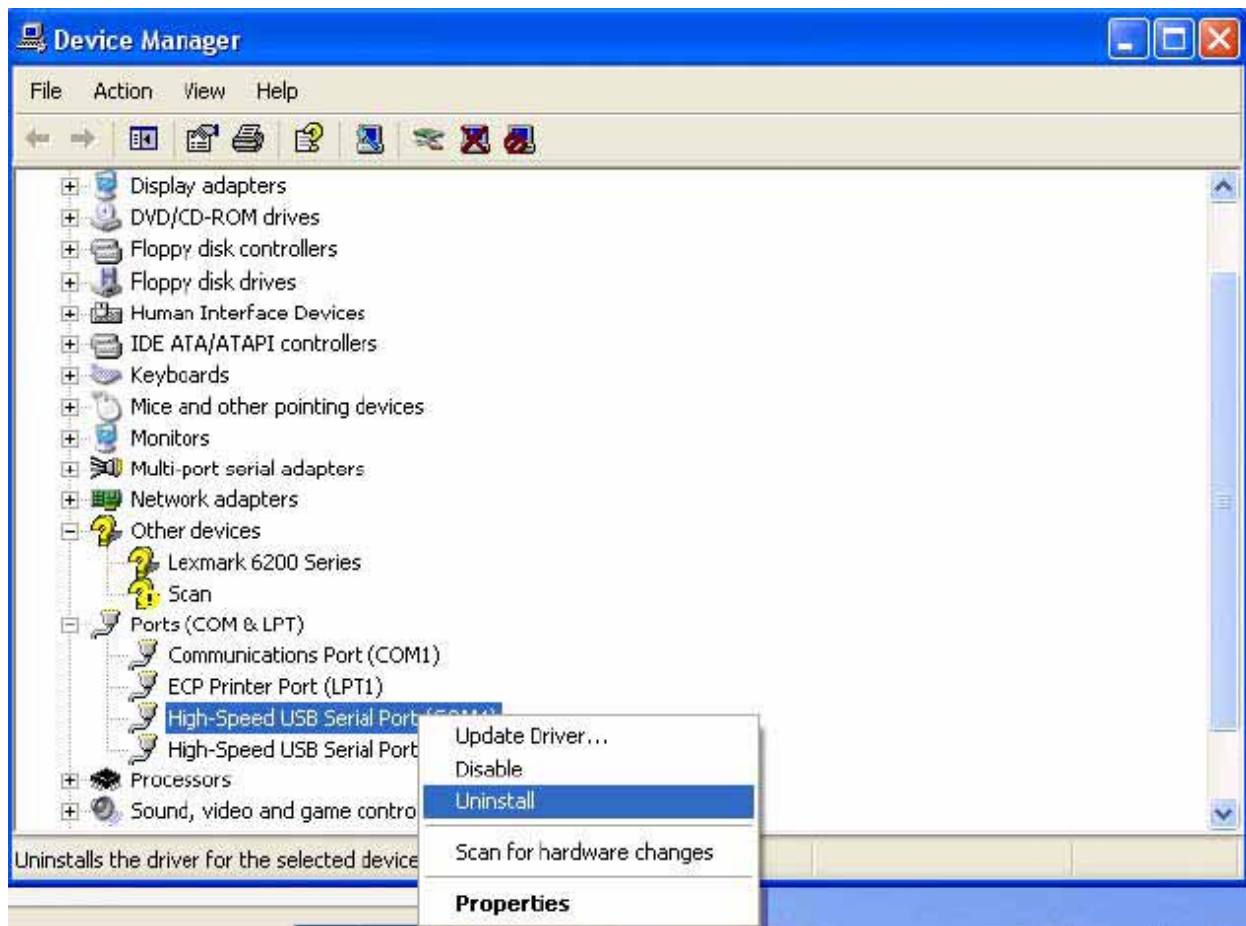

The OS will prompt the user whether to uninstall the device from the system. Click on “OK” to uninstall or “Cancel” to terminate the un-installation.

The Win2K software Installation, Detection and Un-Installation procedures are same as Win XP OS process. The only difference being, there is no need of user intervention during the detection of MCSTRP-C08H. When you connect MCSTRP-C08H to the USB, Win 2000 OS will automatically detect the device without interference of the user.

## 6. How to test TRP-C08H

### 6-1 RS422 Loop Back Test

Hardware wiring connection for RS422 loop test.

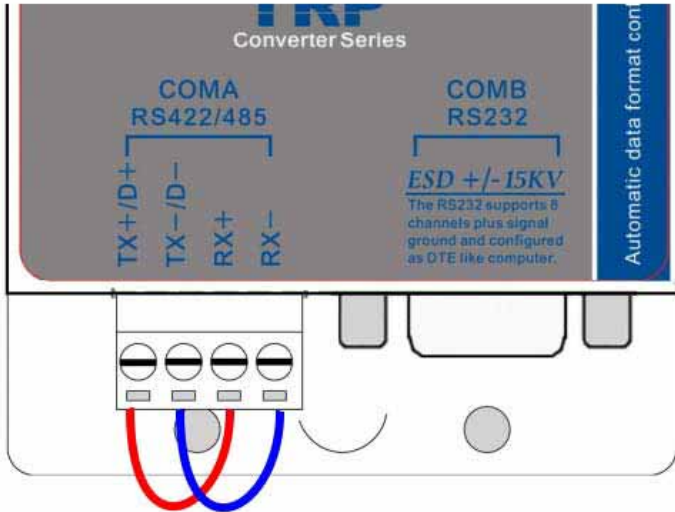

### 6-2 RS232 Loop Back Test

Hardware wiring connection for RS232 Loop Test.

Pin2,3 Short  
Pin7,8 Short

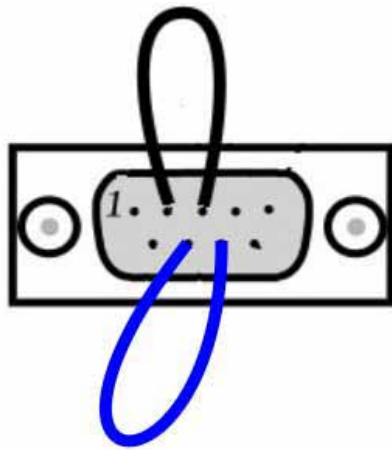

## 6-3 Loop Back Test Software

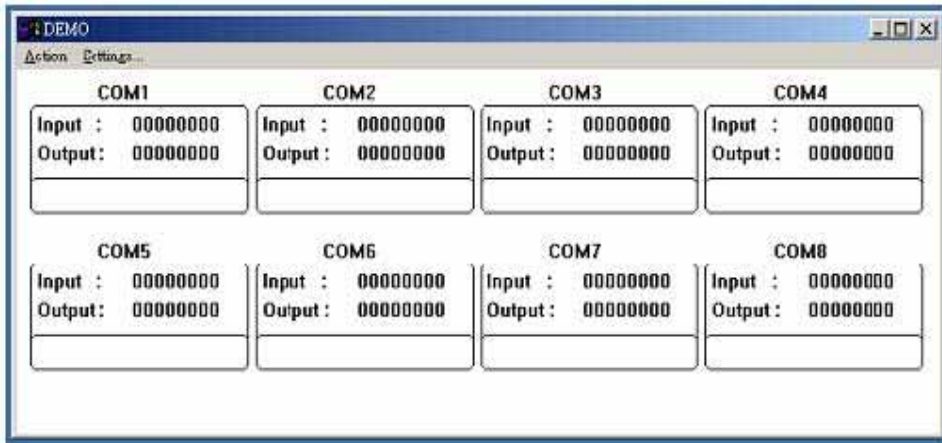

User may find "DEMO.EXE" test utility in TRP-C08H CD. Or download the utility from Trycom web [www.trycom.com.tw](http://www.trycom.com.tw).

- 7 Click the "Setting" to set the RS422 loop counter (See the Figure 6); your system will detect the COM3.

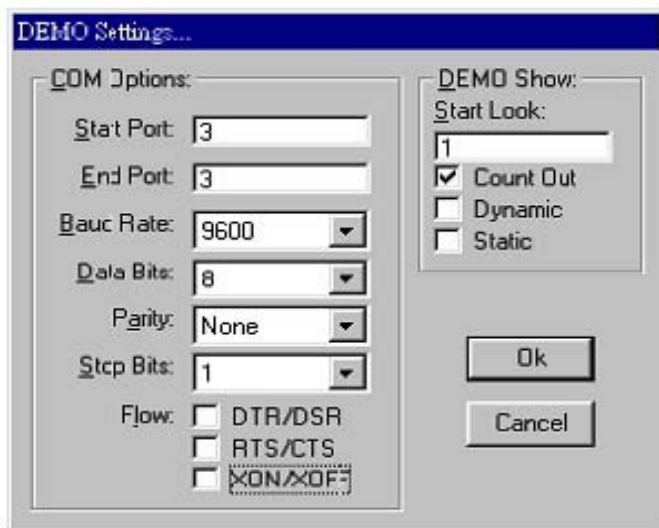

- 8 Click the "Setting" to set the RS232 loop counter (See the Figure 7); your system will detect COM3.

\* Please note: "COM3" is an example of COM port number; user may get a different COM port number after the installation. The actual COM port number is assigned by Windows system.

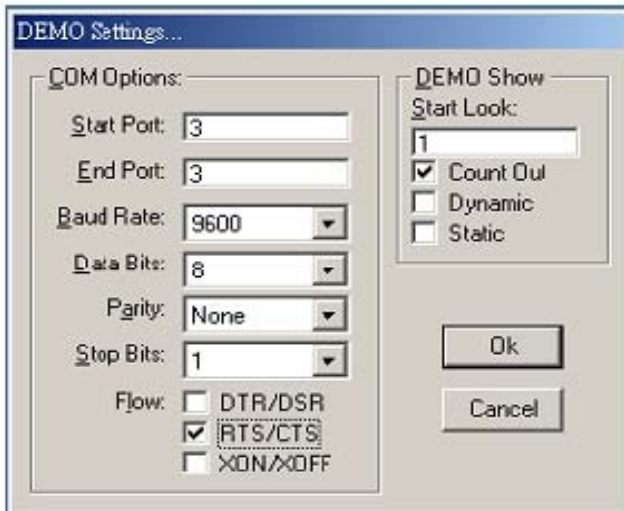

9. Click the “OK” the utility will show the input and output status of RS232.

**7. How to test RS485 TRP-Serial Test Utility** is RS485 communicate software which may help to test TRP-C08H and RS485 device connect. User may find the utility in the TRP-C08H support disk. Double click “Trycom Utility”, the installShield Wizard will guide you complete installation.

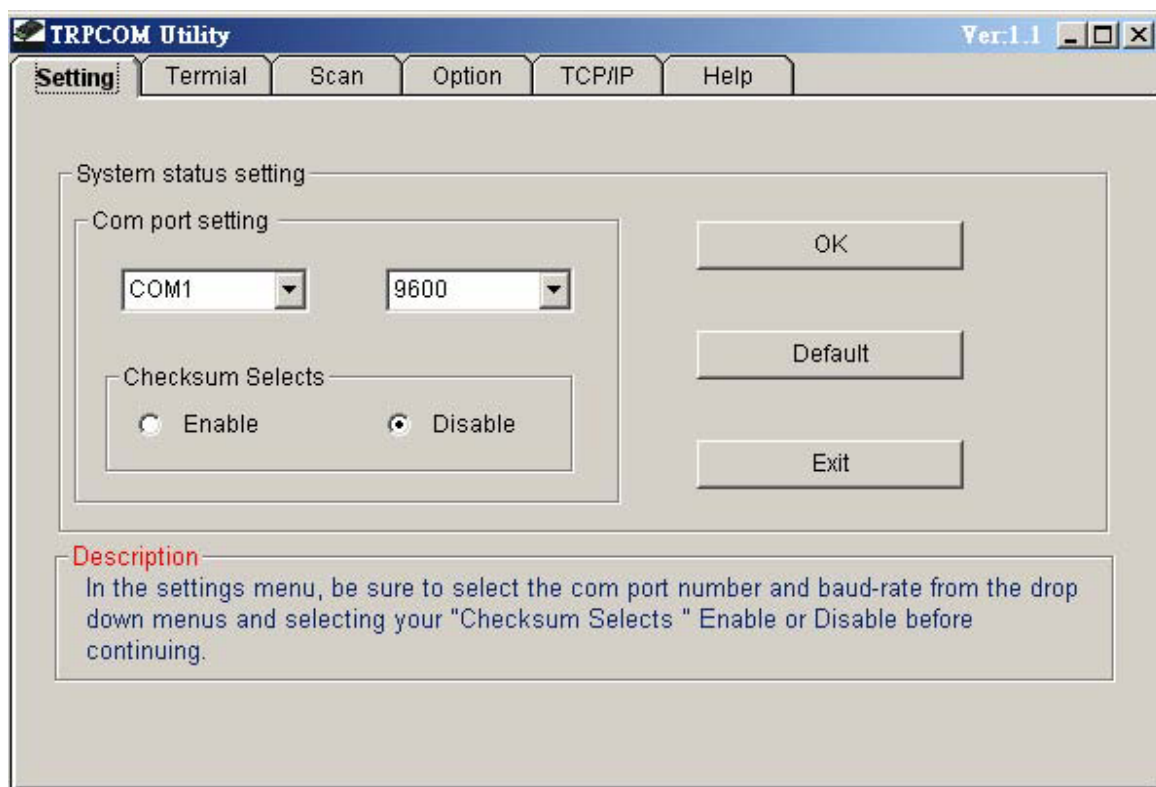

8. TRP-C08H Application.

