

SKET 400



SEMIPACK[®] 4

Thyristor Modules

SKET 400

Features

- Heat transfer through aluminium nitride ceramic isolated metal baseplate
- Precious metal pressure contacts for high reliability
- Thyristor with amplifying gate
- UL recognized, file no. E 63 532

Typical Applications

- DC motor control (e. g. for machine tools)
- Temperature control (e. g. for ovens, chemical processes)
- Professional light dimming (studios, theaters)

- 1) See the assembly instructions
- 2) The screws must be lubricated

V_{RSM} V	V_{RRM}, V_{DRM} V	$I_{TRMS} = 700$ A (maximum value for continuous operation) $I_{TAV} = 400$ A (sin. 180; $T_c = 84$ °C)	
900	800	SKET 400/08E	
1300	1200	SKET 400/12E	
1500	1400	SKET 400/14E	
1700	1600	SKET 400/16E	
1900	1800	SKET 400/18E	

Symbol	Conditions	Values	Units
I_{TAV}	sin. 180; $T_c = 85$ (100) °C;	392 (280)	A
I_D	P16/300F; $T_a = 35$ °C; B2 / B6	700 / 880	A
I_{RMS}	P16/400F; $T_a = 35$ °C; W1 / W3	905 / 3 * 720	A
I_{TSM}	$T_{vj} = 25$ °C; 10 ms	14000	A
	$T_{vj} = 130$ °C; 10 ms	12000	A
i^2t	$T_{vj} = 25$ °C; 8,3 ... 10 ms	980000	A ² s
	$T_{vj} = 130$ °C; 8,3 ... 10 ms	720000	A ² s
V_T	$T_{vj} = 25$ °C; $I_T = 2400$ A	max. 1,7	V
$V_{T(TO)}$	$T_{vj} = 130$ °C	max. 0,92	V
r_T	$T_{vj} = 130$ °C	max. 0,3	mΩ
I_{DD}, I_{RD}	$T_{vj} = 130$ °C; $V_{RD} = V_{RRM}, V_{DD} = V_{DRM}$	max. 80	mA
t_{gd}	$T_{vj} = 25$ °C; $I_G = 1$ A; $di_G/dt = 1$ A/μs	1	μs
t_{gr}	$V_D = 0,67 * V_{DRM}$	2	μs
$(di/dt)_{cr}$	$T_{vj} = 130$ °C	max. 125	A/μs
$(dv/dt)_{cr}$	$T_{vj} = 130$ °C	max. 1000	V/μs
t_q	$T_{vj} = 130$ °C	150 ... 200	μs
I_H	$T_{vj} = 25$ °C; typ. / max.	150 / 500	mA
I_L	$T_{vj} = 25$ °C; $R_G = 33$ Ω; typ. / max.	500 / 2000	mA
V_{GT}	$T_{vj} = 25$ °C; d.c.	min. 3	V
I_{GT}	$T_{vj} = 25$ °C; d.c.	min. 200	mA
V_{GD}	$T_{vj} = 130$ °C; d.c.	max. 0,25	V
I_{GD}	$T_{vj} = 130$ °C; d.c.	max. 10	mA
$R_{th(j-c)}$	cont.	0,09	K/W
$R_{th(j-c)}$	sin. 180	0,095	K/W
$R_{th(j-c)}$	rec. 120	0,11	K/W
$R_{th(c-s)}$		0,02	K/W
T_{vj}		- 40 ... + 130	°C
T_{stg}		- 40 ... + 130	°C
V_{isol}	a. c. 50 Hz; r.m.s.; 1s / 1 min.	3600 / 3000	V~
M_s	to heatsink	5 ± 15 % ¹⁾	Nm
M_t	to terminal	17 ± 15 % ²⁾	Nm
a		5 * 9,81	m/s ²
m	approx.	940	g
Case		A 36	



SKET

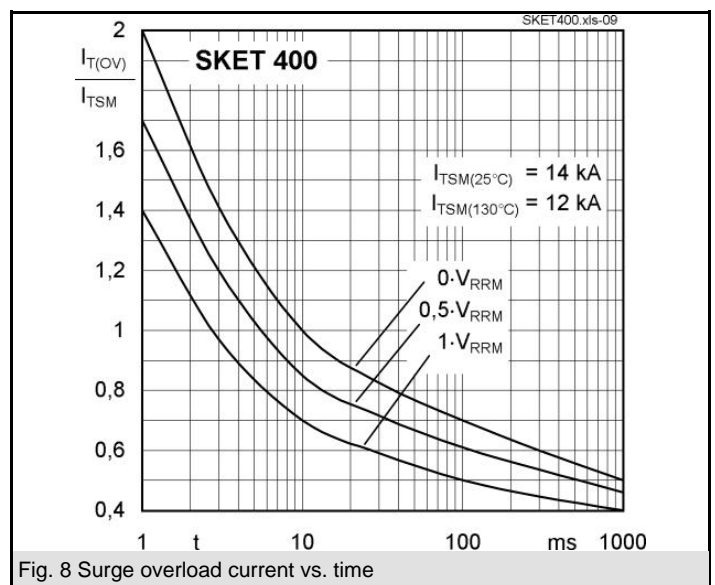
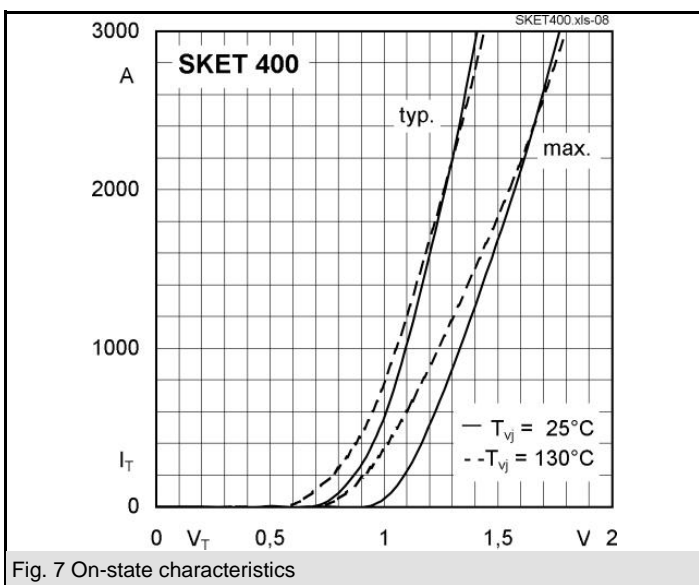
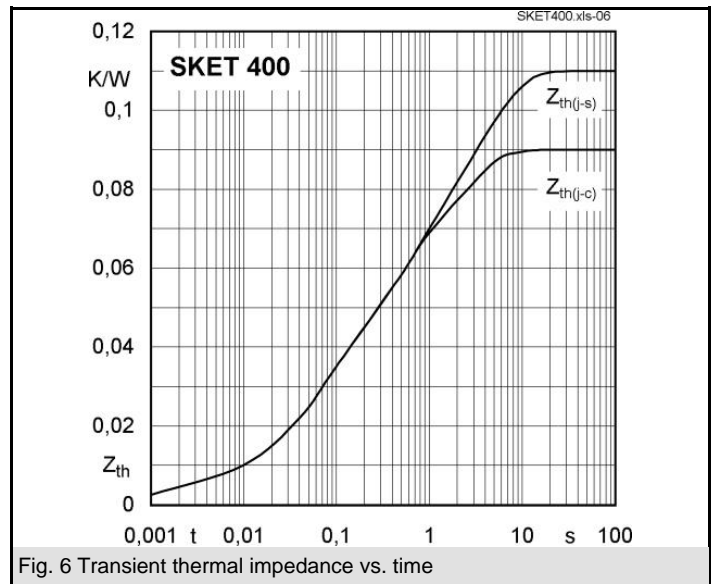
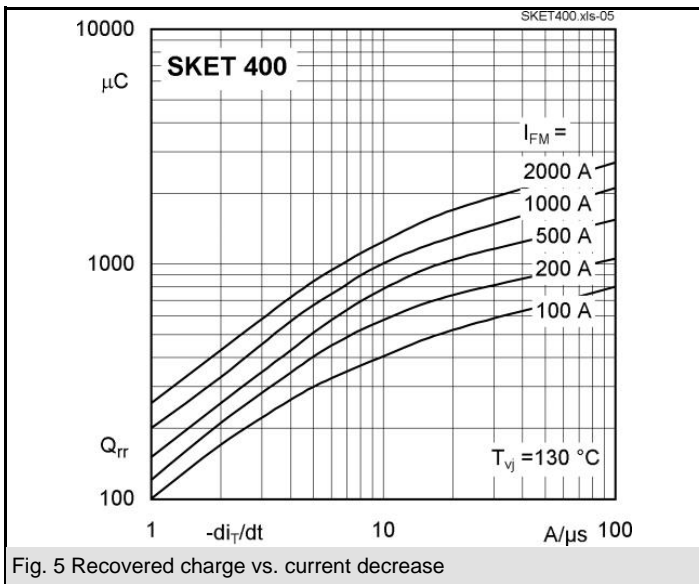
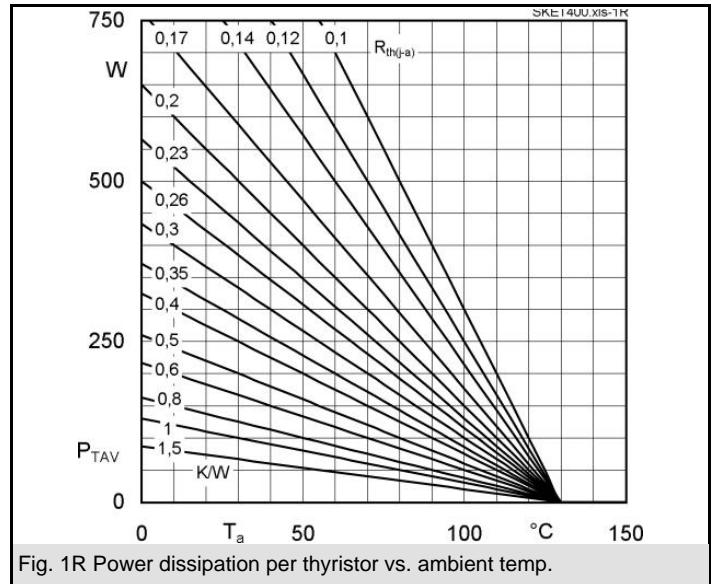
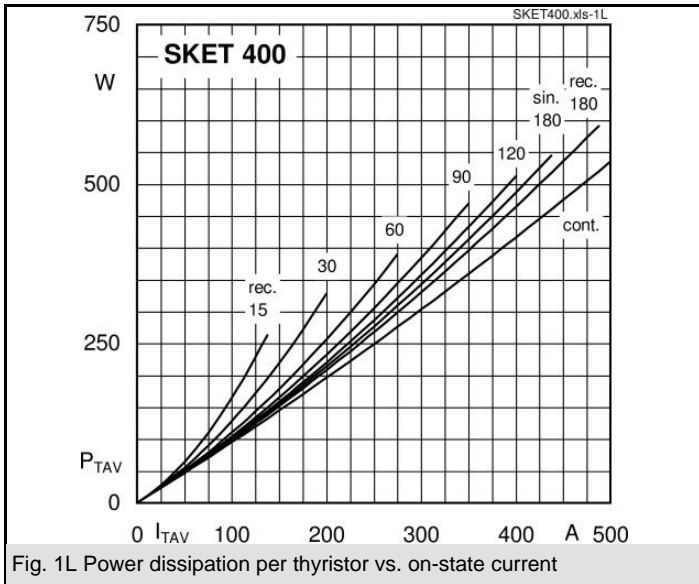

SKET 400

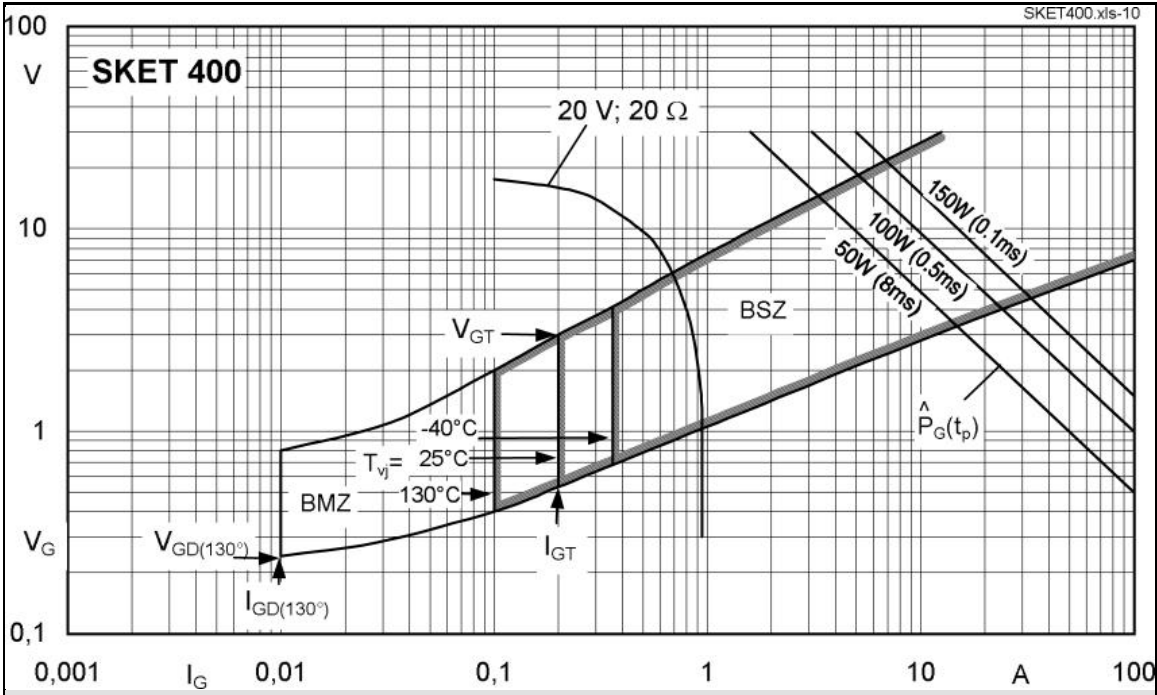
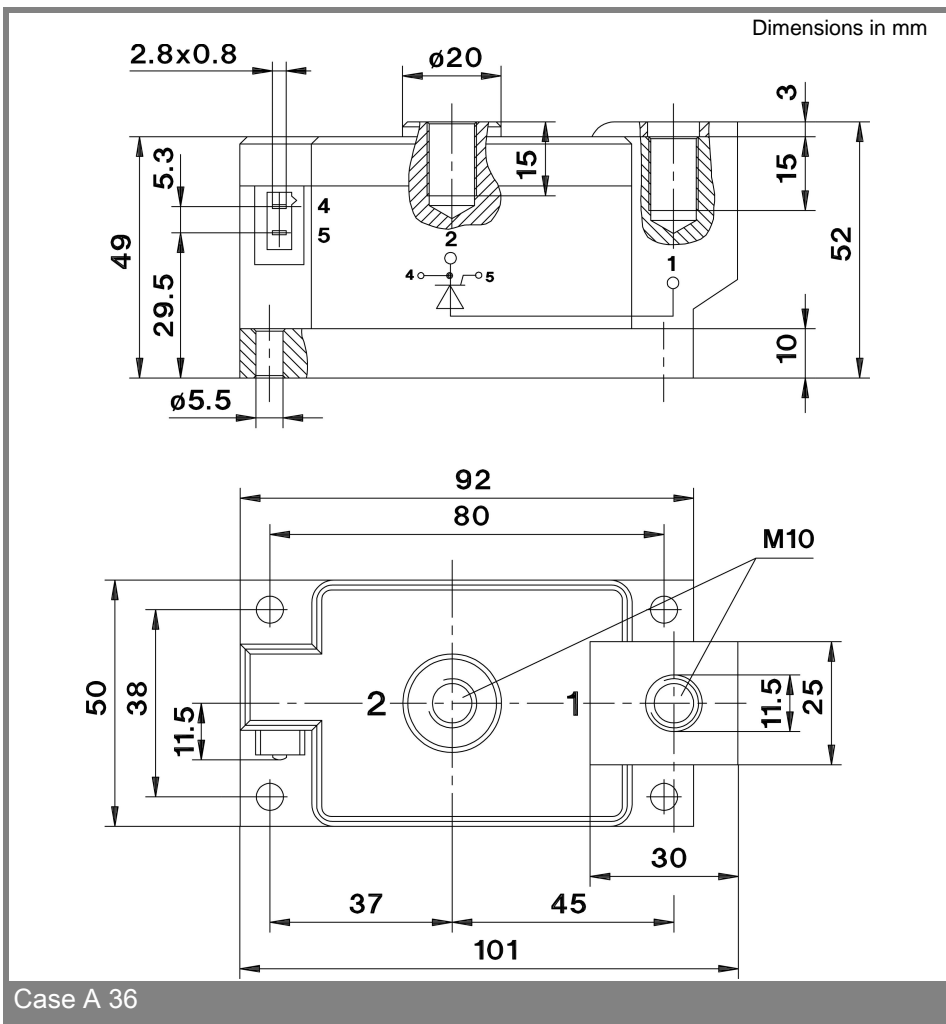

Fig. 9 Gate trigger characteristics



This technical information specifies semiconductor devices but promises no characteristics. No warranty or guarantee expressed or implied is made regarding delivery, performance or suitability.